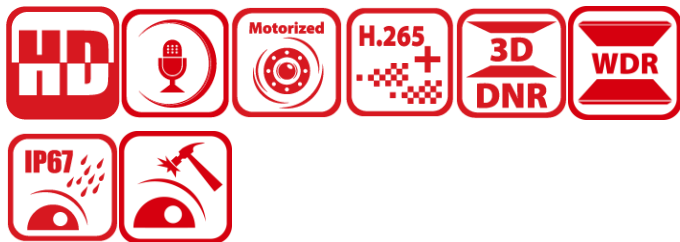

DS-2CD3D4G3E-IT/LIUF**4 MP Smart Hybrid Light Varifocal Dome Network Camera**

Hikvision has been dedicated to develop products with security since established. Hikvision always follows security by design principle and has adopted many methods of security technologies into our product development lifecycle, including terminal security, data security, application security, network security, and privacy protection. In the meantime, the security technologies used by Hikvision are all in compliance with local applicable laws and safety regulations. These security measures could enhance product's cyber security protection capability and protect your devices as well as your data from malicious cyber attacks.

- High quality imaging with 4 MP resolution
- Support Human and Vehicle Detection
- Efficient H.265+ compression technology
- Smart Hybrid Light: advanced technology with long range
- Clear imaging against strong back light due to 120 dB WDR technology
- Easy installation with Power over Ethernet (PoE) technology
- 3D DNR technology delivers clean and sharp images
- Motorized varifocal lens for easy installation and monitoring
- Water and dust resistant (IP67) and vandal proof (IK10)

▪ Specification

Camera	
Image Sensor	1/2.9" Progressive Scan CMOS
Max. Resolution	2560 × 1440
Shutter Time	1/3 s to 1/100,000 s
Min. Illumination	Color: 0.005 Lux @ (F1.6, AGC ON), 0 Lux with light
Day & Night	IR cut filter
Angle Adjustment	Pan: 0° to 355°, tilt: 0° to 75°, rotate: 0° to 355°
Lens	
Lens Type	Varifocal lens, motorized lens, 2.7 to 13.5 mm
Focal Length & FOV	2.7 to 13.5 mm, horizontal FOV 96.7° to 29.7°, vertical FOV 51.7° to 16.7°, diagonal FOV 114.3° to 34.0°
Lens Mount	Ø14
Iris Type	Fixed
Aperture	Max. F1.6
Depth of Field	Wide: 1 m to ∞ Tele: 4.1 m to ∞
DORI	
DORI	Wide: D: 64 m, O: 25.4 m, R: 12.8 m, I: 6.4 m Tele: D: 198 m, O: 78.6 m, R: 39.6 m, I: 19.8 m
Illuminator	
Supplement Light Type	IR, White Light
Supplement Light Range	Up to 30 m
Smart Supplement Light	Yes
IR Wavelength	850 nm
Video	
Main Stream	50 Hz: 20 fps (2560 × 1440), 25 fps (1920 × 1080, 1280 × 720) 60 Hz: 20 fps (2560 × 1440), 30 fps (1920 × 1080, 1280 × 720)
Sub-Stream	50 Hz: 25 fps (1280 × 720, 640 × 480, 640 × 360) 60 Hz: 30 fps (1280 × 720, 640 × 480, 640 × 360)
Third Stream	50 Hz: 1 fps (640 × 360) 60 Hz: 1 fps (640 × 360)
Video Compression	Main stream: H.265+/H.265/H.264+/H.264, Sub-stream: H.265/H.264/MJPEG, Third stream: H.265/H.264
Video Bit Rate	32 Kbps to 8 Mbps
H.264 Type	Baseline Profile, Main Profile, High Profile
H.265 Type	Main Profile
Bit Rate Control	CBR, VBR
Region of Interest (ROI)	1 fixed region for main stream and sub-stream
Audio	
Audio Type	Mono sound

Environment Noise Filtering	Yes
Audio Sampling Rate	8 kHz/16 kHz
Audio Compression	G.711/G.722.1/G.726/MP2L2/PCM/MP3/AAC-LC
Audio Bit Rate	64 Kbps (G.711ulaw/G.711alaw)/16 Kbps (G.722.1)/16 Kbps (G.726)/32 to 192 Kbps (MP2L2)/8 to 320 Kbps (MP3)/16 to 64 Kbps (AAC-LC)
Network	
Security	Password protection, complicated password, HTTPS encryption, 802.1X authentication (EAP-MD5), watermark, basic and digest authentication for HTTP/HTTPS, WSSE and digest authentication for Open Network Video Interface, RTP/RTSP over HTTPS, security audit log, TLS 1.2, TLS 1.3, host authentication (MAC address)
Simultaneous Live View	Up to 6 channels
API	Open Network Video Interface (Profile S, Profile T, Profile G), ISAPI, SDK
Protocols	TCP/IP, ICMP, DHCP, DNS, HTTP, RTP, RTSP, RTCP, NTP, IGMP, IPv4, IPv6, UDP, QoS, FTP, SMTP, HTTPS, DDNS, UPnP, 802.1X
User/Host	Up to 32 users 3 user levels: administrator, operator, and user
Client	iVMS-4200, Hik-Connect
Web Browser	Plug-in required live view: IE 10, IE 11, Local service: Chrome 57.0+, Firefox 52.0+, Edge 89+
Image	
Wide Dynamic Range (WDR)	120 dB
SNR	≥ 52 dB
Day/Night Switch	Day, Night, Auto, Schedule
Image Enhancement	BLC, HLC, 3D DNR
Image Settings	Rotate mode, saturation, brightness, contrast, sharpness, gain, white balance, adjustable by client software or web browser
Privacy Mask	4 programmable polygon privacy masks
Interface	
Ethernet Interface	1 RJ45 10 M/100 M self-adaptive Ethernet port
On-Board Storage	Built-in memory card slot, support microSD/microSDHC/microSDXC card, up to 512 GB
Audio	1 input (line in), two-core terminal block, max. input amplitude: 3.3 Vpp, input impedance: 4.7 KΩ, interface type: non-equilibrium, 1 output (line out), two-core terminal block, max. output amplitude: 3.3 Vpp, output impedance: 100 Ω, interface type: non-equilibrium
Alarm	1 input, 1 output (max. 12 VDC, 30 mA)
Reset Key	Yes
Event	
Basic Event	Motion detection (support alarm triggering by specified target types (human and vehicle)), video tampering alarm, exception
Smart Event	Line crossing detection, intrusion detection
Linkage	Upload to FTP/memory card, notify surveillance center, send email, trigger recording, trigger capture, audible warning
General	
Power	12 VDC ± 25%, 0.8 A, max. 9.6 W, Ø5.5 mm coaxial power plug, reverse polarity protection, PoE: IEEE 802.3af, Class 3, max. 12 W

Material	Aluminum alloy
Dimension	Ø121.5 mm × 97.6 mm (Ø4.78" × 3.84")
Package Dimension	150 mm × 150 mm × 141 mm (5.9" × 5.9" × 5.6")
Weight	Approx. 600 g (1.3 lb.)
With Package Weight	Approx. 830 g (1.8 lb.)
Storage Conditions	-30 °C to 60 °C (-22 °F to 140 °F). Humidity 95% or less (non-condensing)
Startup and Operating Conditions	-30 °C to 60 °C (-22 °F to 140 °F). Humidity 95% or less (non-condensing)
Language	English, Turkish, Polish, Romanian, Czech, Slovak, Traditional Chinese, Thai, Vietnamese, Croatian, Slovenian, Serbian, Ukrainian
General Function	Heartbeat, mirror, password reset via email, pixel counter, password protection, anti-banding
Approval	
EMC	CE-EMC: EN 55032:2015+A1:2020, EN 50130-4:2011+A1:2014, EN IEC 61000-3-2:2019+A1:2021, EN 61000-3-3:2013+A1:2019+A2:2021, IC: ICES-003: Issue 7
Safety	UL: UL 62368-1, CB: IEC 62368-1: 2014+A11, CE-LVD: EN 62368-1: 2014/A11: 2017, BIS: IS 13252 (Part 1): 2010/IEC 60950-1: 2005
Environment	CE-RoHS: 2011/65/EU
Protection	IP67: IEC 60529-2013, IK10: IEC 62262:2002

▪ Typical Application

Hikvision products are classified into three levels according to their anti-corrosion performance. Refer to the following description to choose for your using environment.

This model has NO SPECIFIC PROTECTION.

Level	Description
Top-level protection	Hikvision products at this level are equipped for use in areas where professional anti-corrosion protection is a must. Typical application scenarios include coastlines, docks, chemical plants, and more.
Moderate protection	Hikvision products at this level are equipped for use in areas with moderate anti-corrosion demands. Typical application scenarios include coastal areas about 2 kilometers (1.24 miles) away from coastlines, as well as areas affected by acid rain.
No specific protection	Hikvision products at this level are equipped for use in areas where no specific anti-corrosion protection is needed.

▪ Available Model

DS-2CD3D4G3E-IT/LIUF(2.7-13.5mm)

▪ **Dimension**

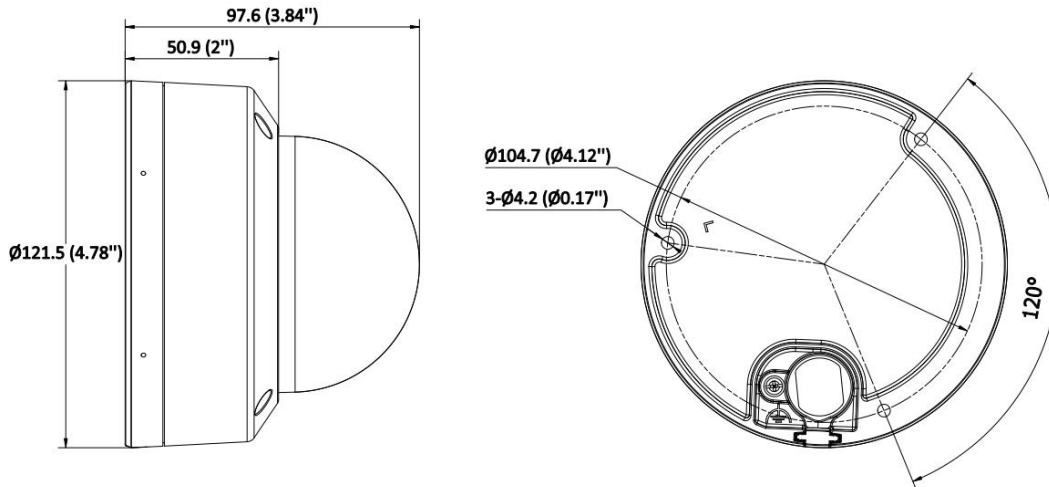

Unit: mm (inch)



▪ **Accessory**

▪ **Optional**

DS-1272ZJ-120	DS-1272ZJ-120B	DS-1271ZJ-120	DS-1275ZJ-SUS	DS-1276ZJ-SUS
				
DS-1280ZJ-DM46	DS-2280ZJ-WA120	DS-2210ZJ-WA-120	DS-2200ZJ-WA-120	DS-2200ZJ-WAJ-120
				

▪ **Installation Methods**

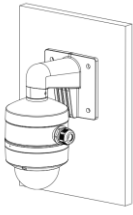
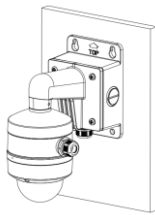
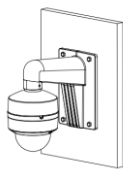
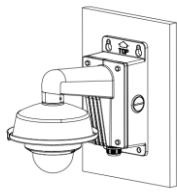
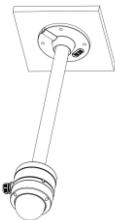
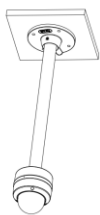
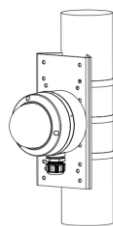
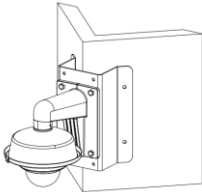
Wall Mounting	Wall Mounting	Wall Mounting	Wall Mounting	Pendant Mounting
DS-1272ZJ-120+DS-1280ZJ-DM46	DS-1272ZJ-120B+DS-1280ZJ-DM46	DS-2200ZJ-WA-120	DS-2200ZJ-WAJ-120+DS-1253ZJ-M	DS-1271ZJ-120+DS-1280ZJ-DM46

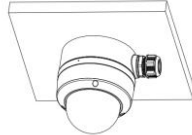
				
Pendant Mounting DS-2210ZJ-WA-120	Vertical Pole Mounting DS-1275ZJ-SUS+DS-2280ZJ-WA120	Corner Mounting DS-1276ZJ-SUS+DS-1272ZJ-120+DS-1253ZJ-M	Junction Box DS-1280ZJ-DM46	Junction Box DS-2280ZJ-WA120
				

See Far, Go Further



www.hikvision.com
support@hikvision.com

